



NÁBYTKOVÁ DVÍŘKA  
OD ČESKÉHO VÝROBCE

## TVAR B0 OŘECH DIJON



plné

výška od 286 mm

prosklené



výška od 286 mm

šířka od 220 mm

mříž



výška od 286 mm

šířka od 260 mm

do výšky 699 mm 4 okna  
od výšky 700 mm 6 oken



zásuvka  
výška 95-285 mm

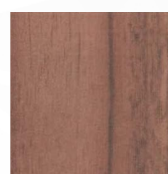

detail



## TVAR B1 OLŠE ČERVENÁ



plné

výška od 180 mm

náhradní tvar B0  
do šířky 194 mm

prosklené



výška od 286 mm

šířka od 220 mm

mříž



výška od 286 mm

šířka od 260 mm

do výšky 699 mm 4 okna  
od výšky 700 mm 6 oken



zásuvka  
výška 95-179 mm



detail

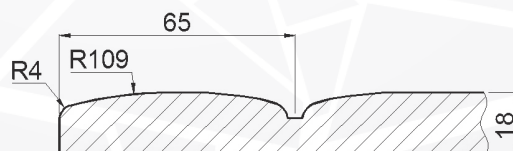

## TVAR B2 MALAGA



plné

výška od 286 mm

prosklené



výška od 286 mm

šířka od 240 mm



detail



zásuvka  
výška 95-285 mm



## TVAR B3 HRUŠEŇ



plné

výška od 180 mm

náhradní tvar B3  
zásuvka do šířky  
188 mm

prosklené



výška od 286 mm

šířka od 220 mm

mříž



výška od 286 mm

šířka od 260 mm

do výšky 699 mm 4 okna  
od výšky 700 mm 6 oken



zásuvka  
výška 95-179 mm

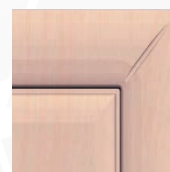

detail

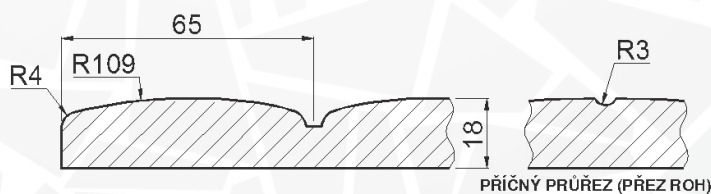

PŘÍČNÝ PRŮŘEZ (PŘEZ ROH)

## TVAR B4 COUNTRY



plné

výška od 170 mm

náhradní tvar **B4**  
zásuvka do šířky  
169 mm

prosklené



výška od 286 mm

šířka od 220 mm



detail



zásuvka  
výška 95-169 mm

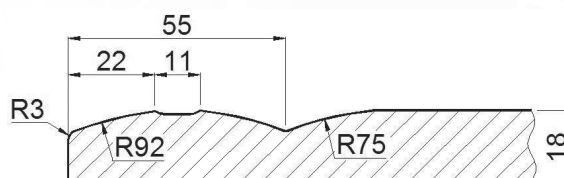

## TVAR C0 KIWI - VYSOKÝ LESK

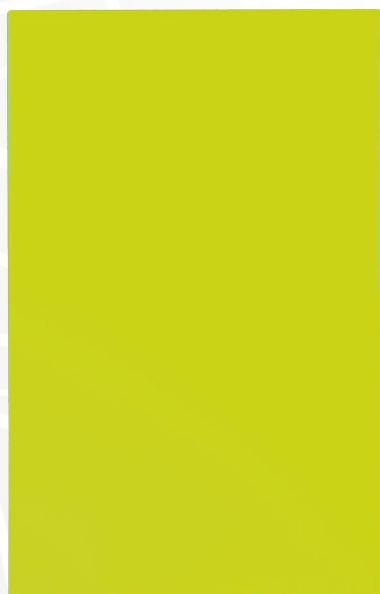

plné

výška od 286 mm

prosklené

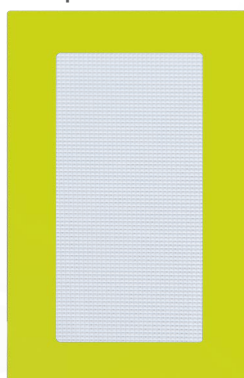

výška od 253 mm

šířka od 220 mm



detail



zásuvka  
výška 95-285 mm



## TVAR C1

DUB ŠEDÝ



plné

výška od 157 mm

náhradní tvar **C0** do šířky 104 mm,  
náhradní tvar **C1M** od šířky 105 mm  
do 156 mm, viz. internet

prosklené



výška od 253 mm

šířka od 220 mm



zásuvka

výška 95-156 mm

mříž



výška od 286 mm

šířka od 260 mm

do výšky 699 mm 4 okna  
od výšky 700 mm 6 oken



detail

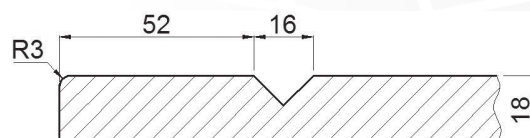

## TVAR D1

BUK



plné

výška od 180 mm

náhradní tvar **R0** do šířky 144 mm,  
náhradní tvar **D1M** od šířky 145 mm do 178 mm,  
viz. internet

prosklené



výška od 253 mm

šířka od 220 mm

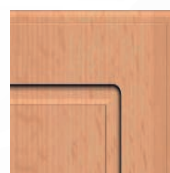

detail



zásuvka

výška 95-179 mm

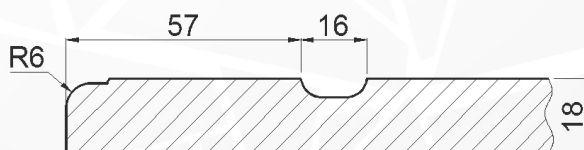

## TVAR D2 VANILKA S



plné

výška od 180 mm

náhradní tvar **R0** do šířky 144 mm,  
náhradní tvar **D2M** od šířky 145 mm  
do 243 mm, viz. internet

prosklené



výška od 253 mm

šířka od 220 mm

mříž



výška od 380 mm

šířka od 240 mm

do šířky 385 mm 4 okna  
od šířky 386 mm 6 oken



zásuvka  
výška 95-179 mm



detail

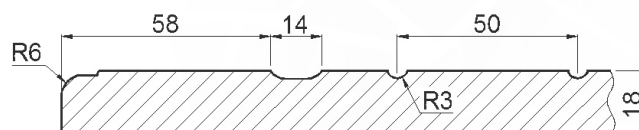

## TVAR D3 BUK PĚŘENÝ



plné

výška od 220 mm

náhradní tvar **R0** do šířky 144 mm,  
náhradní tvar **D3M** od šířky 145 mm do 228 mm,  
viz. internet

prosklené



výška od 253 mm

šířka od 240 mm



detail



zásuvka  
výška 95-219 mm

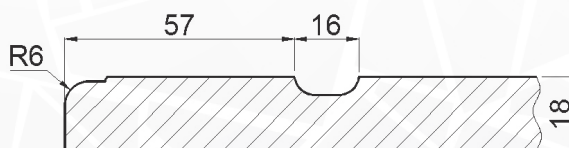

## TVAR D4 CALVADOS

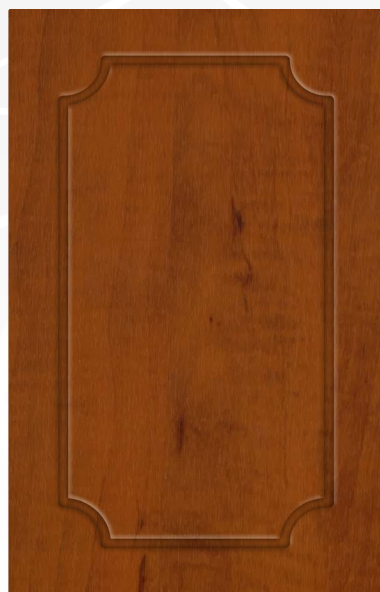

plné

výška od 286 mm

prosklené



výška od 286 mm

šířka od 255 mm

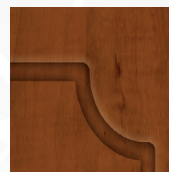

detail

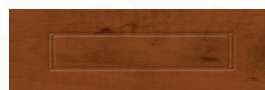

zásuvka  
výška 95-285 mm

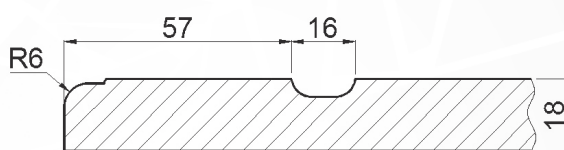

náhradní tvar **R0** do šířky 145 mm, náhradní tvar **D1M** od šířky 146 mm do 194 mm, náhradní tvar **D4M** od šířky 195 mm do 244 mm, viz. internet

## TVAR D5 PÍSEK-SUPER MAT



plné

výška od 126 mm

náhradní tvar **D5** zásuvka  
do šířky 141 mm

prosklené

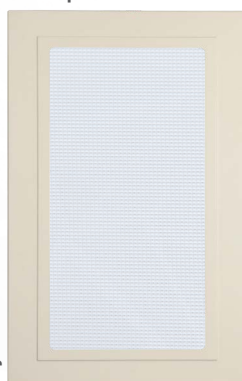

výška od 253 mm

šířka od 220 mm

mříž

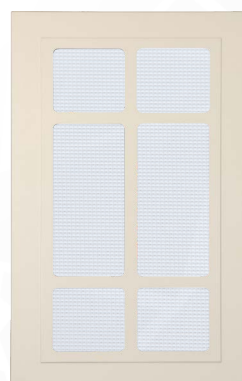

výška od 520 mm

šířka od 270 mm

do šířky 451 mm 6 oken  
od šířky 452 mm 9 oken (3x3 okna)

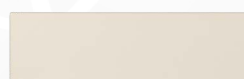

zásuvka  
výška 95-125 mm

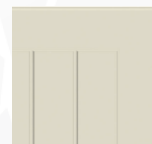

detail

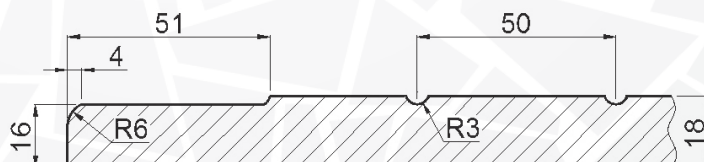

## TVAR E2

DUB NATUR

mříž



plné

výška od 271 mm

pouze obvodové frézování  
do šířky 268 mm

prosklené



výška od 286 mm

šířka od 269 mm



zásuvka  
výška 120-270 mm



výška od 320 mm

šířka od 269 mm

do výšky 699 mm 4 okna  
od výšky 700 mm 6 oken



detail



## TVAR F1

ALABASTR - SUPER MAT

prosklené - typ 1

prosklené - typ 2

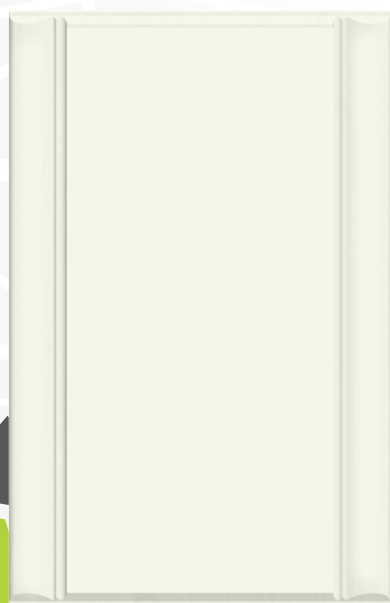

plné

výška od 286 mm

náhradní tvar frézování **F1M**  
do šířky 145 mm

výška od 286 mm

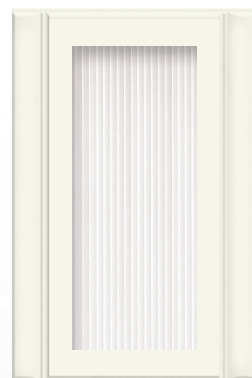

šířka od 250 mm

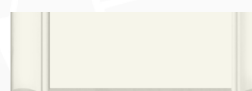

zásuvka  
výška 106-285 mm

výška od 286 mm

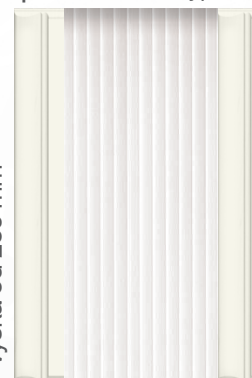

šířka od 245 mm

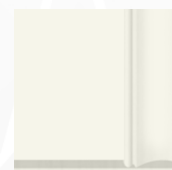

detail

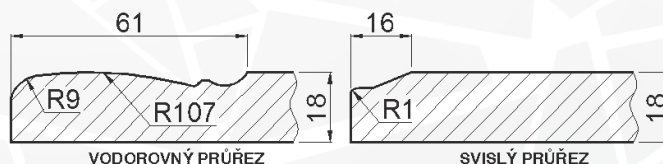

VODOROVNÝ PRŮŘEZ

SVISLÝ PRŮŘEZ



## TVAR GO

OCEL



plné

výška od 286 mm

prosklené



výška od 253 mm

šířka od 220 mm



detail



zásuvka  
výška 95-285 mm



## TVAR H0

JAVOR



plné

výška od 286 mm

prosklené



výška od 253 mm

šířka od 220 mm



detail



zásuvka  
výška 95-285 mm



## TVAR H1 BUK CORA



plné

výška od 220 mm

náhradní tvar **H0** do šířky  
218 mm

výška od 253 mm

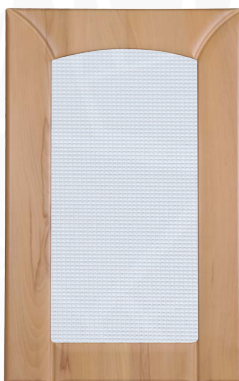

šířka od 285 mm

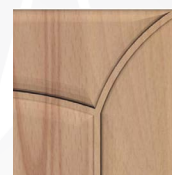

detail



zásuvka  
výška 95-219 mm

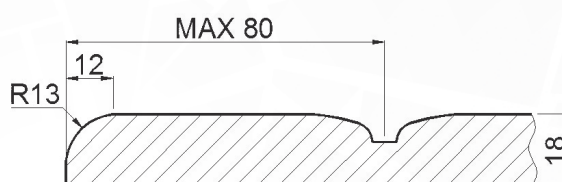

## TVAR H3 DUB ŠEDÝ



plné

výška od 286 mm

náhradní tvar **H0** do šířky  
244 mm

výška od 286 mm

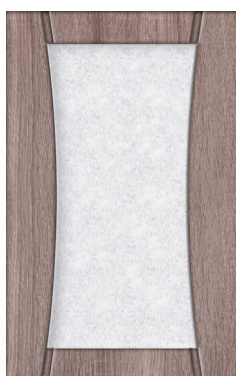

šířka od 245 mm



detail



zásuvka  
výška 95-285 mm



## TVAR H4 HRUŠEN



plné

výška od 286 mm

náhradní tvar **H0** do šířky  
144 mm

prosklené



výška od 286 mm

šířka od 220 mm



detail



zásuvka

výška 95-285 mm



## TVAR H5 OŘECH LYON



plné

výška od 250 mm

náhradní tvar **H0** do šířky  
218 mm

prosklené



výška od 253 mm

šířka od 285 mm



detail



zásuvka

výška 95-249 mm

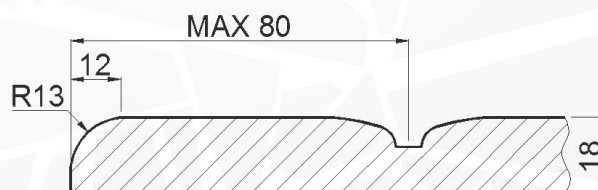

## TVAR H6 DUB SANREMO



plné

výška od 286 mm

náhradní tvar H0 do šířky  
159 mm

prosklené



výška od 253 mm

šířka od 220 mm



detail



zásuvka

výška 95-285 mm

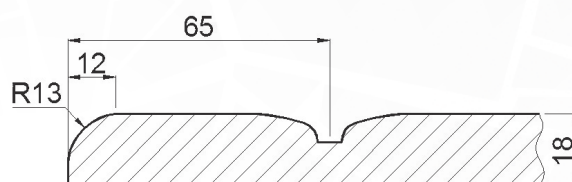

## TVAR H7 OCEÁN



plné

výška od 200 mm

náhradní tvar H7A do šířky  
244 mm, viz. internet

prosklené



výška od 286 mm

šířka od 245 mm



detail



zásuvka

výška 95-219 mm

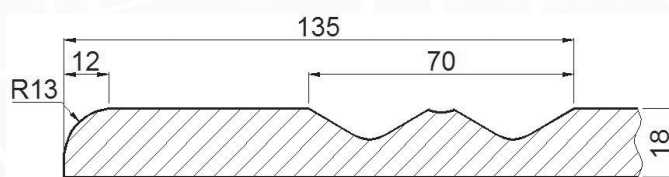

SVISLÝ PRŮŘEZ (STŘEDEM ORNAMENTU)

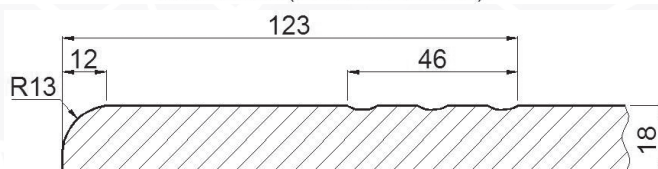

SVISLÝ PRŮŘEZ (ORNAMENTEM)

## TVAR K0 BANÁN

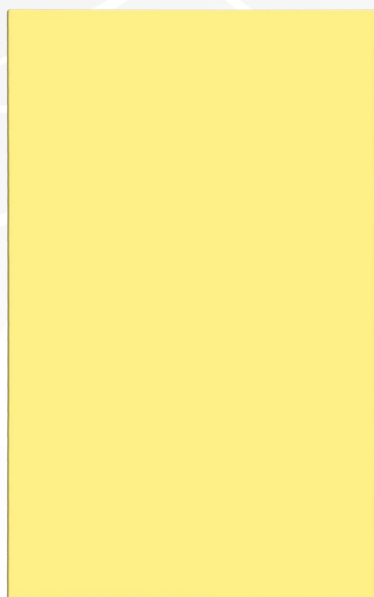

plné

výška od 286 mm

prosklené

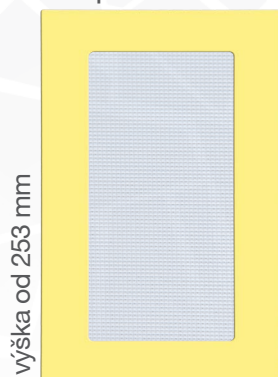

výška od 253 mm

šířka od 220 mm



detail



zásuvka  
výška 95-285 mm



## TVAR K1 DUB TMAVÝ



plné

výška od 221 mm

náhradní tvar K0 do šířky  
187 mm

prosklené

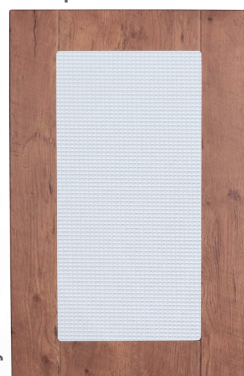

výška od 253 mm

šířka od 220 mm



detail



zásuvka  
výška 95-220 mm

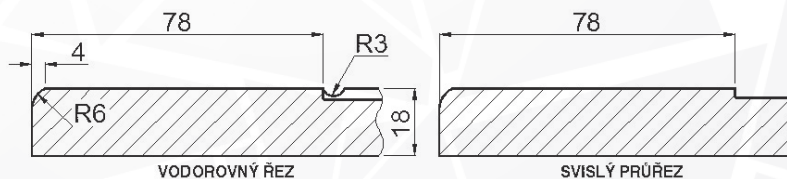

VODOROVNÝ ŘEZ

SVISLÝ PRŮŘEZ

## TVAR K2

KAPUČINO - VYSOKÝ LESK



plné

výška od 180 mm

náhradní tvar K0 do šířky  
187 mm

prosklené



výška od 253 mm

šířka od 220 mm



detail



zásuvka  
výška 95-179 mm

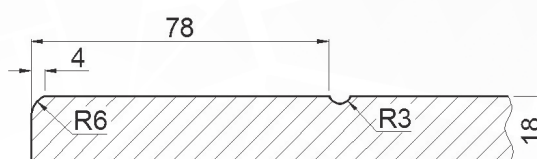

## TVAR K3

ZELENÁ SVĚTLÁ



plné

výška od 253 mm

náhradní tvar K0 do šířky  
187 mm

prosklené



výška od 286 mm

šířka od 220 mm



detail



zásuvka  
výška 95-252 mm

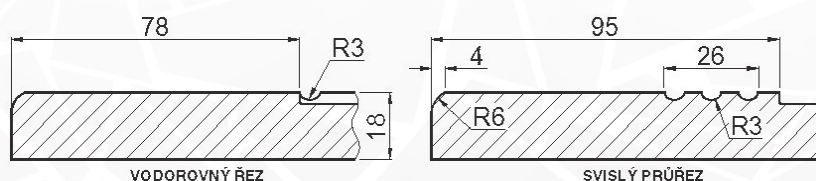

## TVAR K4 BÍLÁ PERLIČKA



plné

výška od 220 mm

náhradní tvar K0 do šířky  
187 mm

prosklené

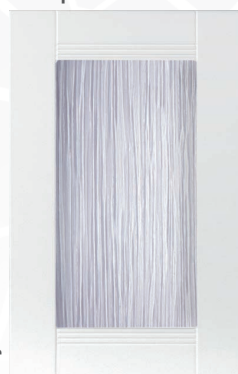

výška od 286 mm

šířka od 220 mm



detail



zásuvka  
výška 95-219 mm

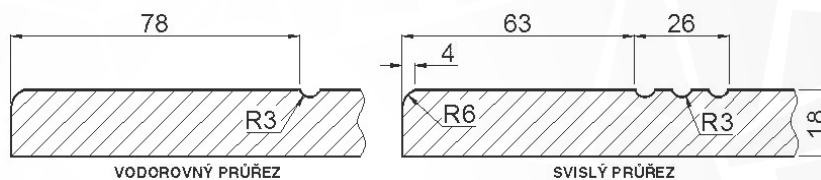

## TVAR K5 GREP



plné

výška od 221 mm

náhradní tvar K0 do šířky  
187 mm

prosklené



výška od 253 mm

šířka od 220 mm

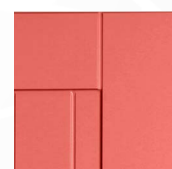

detail



zásuvka  
výška 95-220 mm

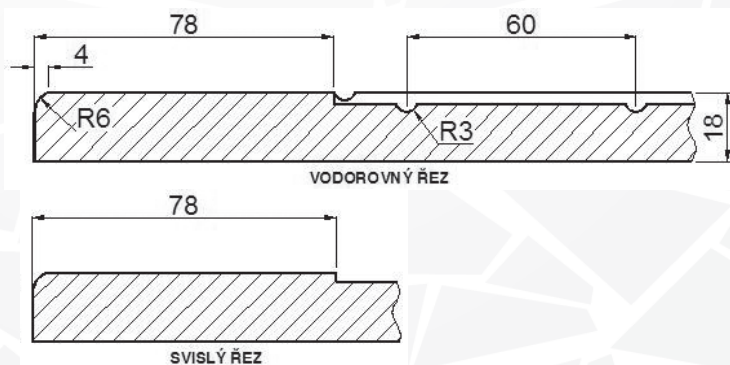

## TVAR **K6** MERÁNO



plné

výška od 253 mm

náhradní tvar **K0** do šířky 180 mm, náhradní tvar **K6M** od šířky 181 mm do 225 mm, viz. internet

prosklené



výška od 286 mm

šířka od 220 mm

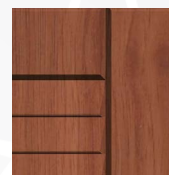

detail



zásuvka  
výška 106-252 mm

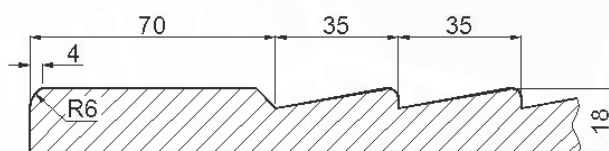

SVISLÝ PRŮŘEZ

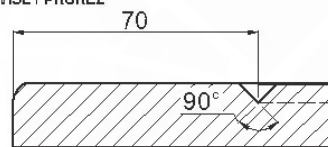

PODÉLNÝ ŘEZ

## TVAR **M0** ZELENÁ SVĚTLÁ



plné

výška od 286 mm

prosklené

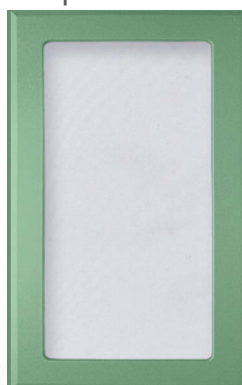

výška od 253 mm

šířka od 220 mm



detail



zásuvka  
výška 95-285 mm





## TVAR M1

PINIE



plné

výška od 286 mm

prosklené



výška od 253 mm

šířka od 220 mm

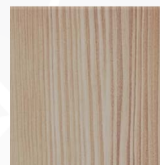

detail



zásuvka

výška 106-285 mm



## TVAR O1

OLŠE ČERVENÁ + BÍLÁ PERLIČKA

prosklené



plné

výška od 286 mm

náhradní tvar H0 do šířky  
187 mm

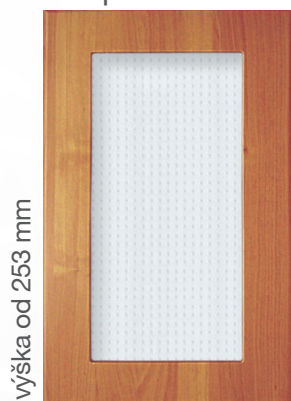

výška od 253 mm

šířka od 220 mm



detail



zásuvka

výška 106-285 mm

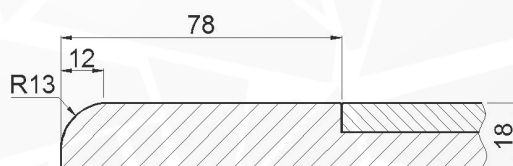

## TVAR O2

OŘECH DIJON + VANILKA S



plné

výška od 286 mm

náhradní tvar **K0** do šířky  
187 mm

prosklené

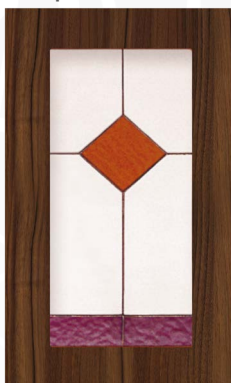

výška od 253 mm

šířka od 220 mm

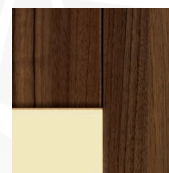

detail

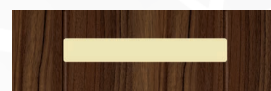

zásuvka

výška 106-285 mm

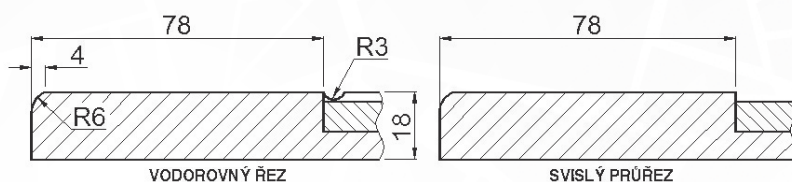

## TVAR R0

DUB NATUR



plné

výška od 286 mm

prosklené



výška od 253 mm

šířka od 220 mm

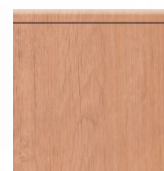

detail



zásuvka

výška 95-285 mm



## TVAR R1

BOROVICE



plné

výška od 196 mm

náhradní tvar **R0** do šířky 105 mm,  
náhradní tvar **R1M** od šířky 106 mm  
do 194 mm, viz. internet

prosklené



výška od 253 mm

šířka od 220 mm

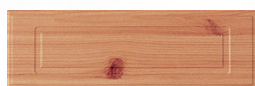

zásuvka  
výška 95-195 mm

mříž



výška od 253 mm

šířka od 220 mm

do výšky 699 mm 4 okna  
od výšky 700 mm 6 oken



detail

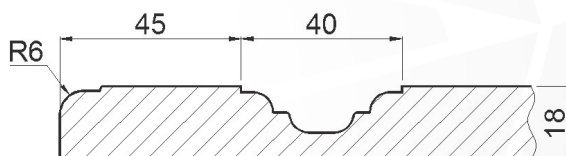

## TVAR R2

DUB 2



plné

výška od 250 mm

náhradní tvar **R0** do šířky 144 mm,  
náhradní tvar **R1** zásuvka od šířky  
145 mm do 194 mm, náhradní tvar  
**R2M** od šířky 195 mm do 224 mm,  
viz. internet

prosklené



výška od 253 mm

šířka od 225 mm



zásuvka  
výška 95-249 mm



výška od 365 mm

šířka od 250 mm

do výšky 699 mm 4 okna  
od výšky 700 mm 6 oken



detail

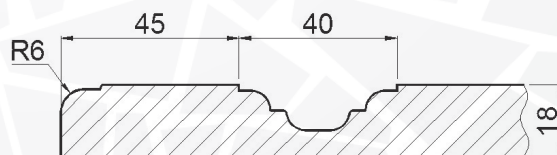

## TVAR R3 PINIE BÍLÁ



plné

výška od 250 mm

náhradní tvar **R0** do šířky 105 mm,  
náhradní tvar **R1M** od šířky 106 mm  
do 145 mm, viz. internet  
náhradní tvar **R3M** od šířky 146 mm  
do 228 mm

prosklené



výška od 253 mm

šířka od 235 mm



zásuvka

výška 95-249 mm

mříž



výška od 360 mm

šířka od 240 mm

do výšky 699 mm 4 okna  
od výšky 700 mm 6 oken



detail

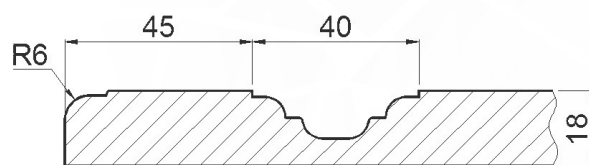

## TVAR R4 DUB SUKATÝ



plné

výška od 286 mm

náhradní tvar **R0** do šířky 144 mm,  
náhradní tvar **R1M** zásuvka od šířky  
145 mm do 194 mm, náhradní tvar  
**R4M** od šířky 195 mm do 254 mm,  
viz. internet

prosklené



výška od 286 mm

šířka od 255 mm



zásuvka

výška 95-285 mm

mříž

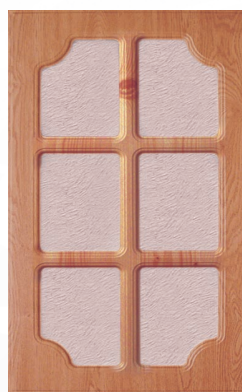

výška od 286 mm

šířka od 280 mm

do výšky 699 mm 4 okna  
od výšky 700 mm 6 oken

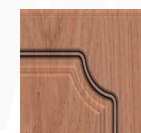

detail

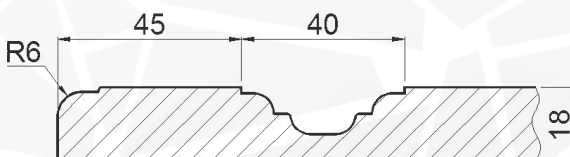

## TVAR R5 VANILKA



plné

výška od 250 mm

náhradní tvar **R0** do šířky 105 mm, náhradní tvar **R1M** od šířky 106 mm do 194 mm, náhradní tvar **R1** od šířky 195 mm do 339 mm, viz. internet

prosklené  
šířka od 340 mm



výška od 253 mm

od 220 mm do 339 mm  
náhradní **R1** prosklené



zásuvka  
výška 95-249 mm

mříž



výška od 300 mm

šířka od 340 mm  
od 220 mm do 339 mm náhradní **R1** prosklené

do výšky 699 mm 4 okna  
od výšky 700 mm 6 oken



detail

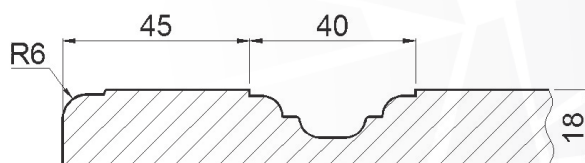

## TVAR 31 BÍLÝ FLÁDR



plné

výška od 286 mm

náhradní tvar **B0** do šířky 144 mm

prosklené



výška od 286 mm

šířka od 220 mm

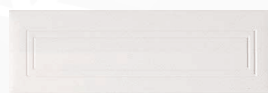

zásuvka  
výška 106-285 mm

mříž



výška od 286 mm

šířka od 225 mm

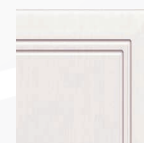

detail

do výšky 699 mm 4 okna  
od výšky 700 mm 6 oken



## TVAR 32 PERLEŤ ŠEDÁ



plné

výška od 286 mm

prosklené



výška od 253 mm

šířka od 220 mm

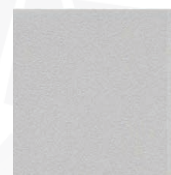

detail



výška  
95-285 mm

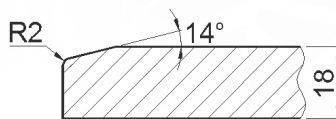

PODÉLNÝ PRŮŘEZ



SVISLÝ PRŮŘEZ

## TVAR 33 ŠEDÁ - SUPER MAT



plné

výška od 286 mm

náhradní tvar 32 do šířky  
98 mm

prosklené



výška od 253 mm

šířka od 220 mm



detail



zásuvka  
výška 95-285 mm

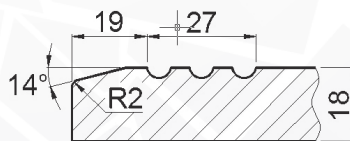

PODÉLNÝ PRŮŘEZ



SVISLÝ PRŮŘEZ

## TVAR 34 OLIVA METAL



plné

výška od 286 mm

náhradní tvar 32 do šířky 98 mm,  
náhradní tvar 33 od šířky 99 mm  
do 124 mm

prosklené



výška od 253 mm

šířka od 220 mm



detail



zásuvka  
výška 95-285 mm

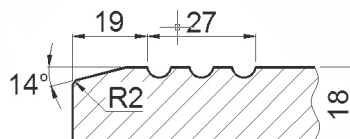

PODÉLNÝ PRŮŘEZ



SVISLÝ PRŮŘEZ

## TVAR 41 DUB HORSKÝ



plné

výška od 220 mm

náhradní tvar 40 do šířky 99 mm,  
náhradní tvar 41M od šířky 100  
mm do 218 mm, viz. internet

prosklené



výška od 253 mm

šířka od 220 mm

mříž



výška od 265 mm

šířka od 220 mm

do výšky 699 mm 4 okna  
od výšky 700 mm 6 oken



zásuvka  
výška 106-219 mm

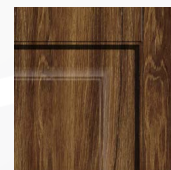

detail

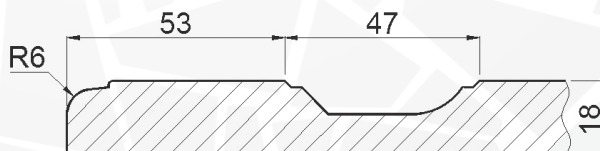

## TVAR 42

DUB MOKKA  
mříž

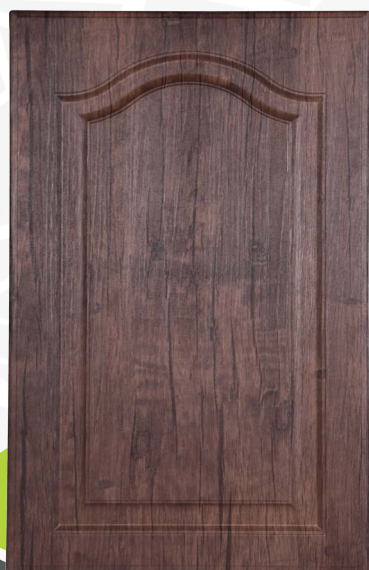

plné

výška od 250 mm

náhradní tvar 40 do šířky 99 mm, náhradní tvar 41M od šířky 100 mm do 124 mm, náhradní tvar 42M od šířky 125 mm do 258 mm, viz. internet

prosklené

výška od 253 mm



šířka od 260 mm



zásuvka

výška 106-249 mm

výška od 295 mm



šířka od 260 mm

do výšky 699 mm 4 okna  
od výšky 700 mm 6 oken

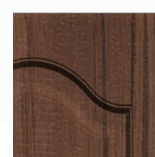

detail

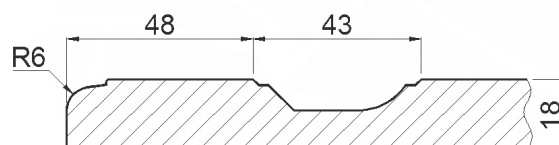

## TVAR 43

DUB SANTÁNA



plné

výška od 250 mm

náhradní tvar 40 do šířky 99 mm, náhradní tvar 41M od šířky 100 mm do 124 mm, náhradní tvar 43M od šířky 125 mm do 258 mm, viz. internet

prosklené

výška od 253 mm



šířka od 260 mm



zásuvka

výška 106-249 mm

výška od 295 mm



šířka od 260 mm

do výšky 699 mm 4 okna  
od výšky 700 mm 6 oken



detail

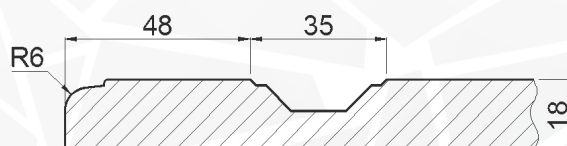



## TVAR 44 VANILKA S



plné

výška od 200 mm

náhradní tvar **M0** do šířky 134 mm,  
náhradní tvar **44M** od šířky 135  
mm do 198 mm, viz. internet

prosklené

výška od 286 mm



šířka od 220 mm



detail

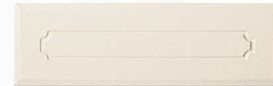

zásuvka

výška 106-199 mm

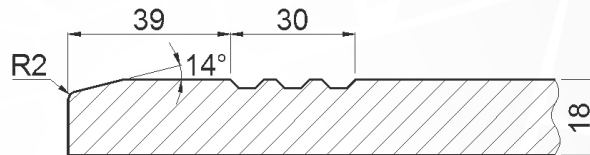

## TVAR 46 DUB ANTIK

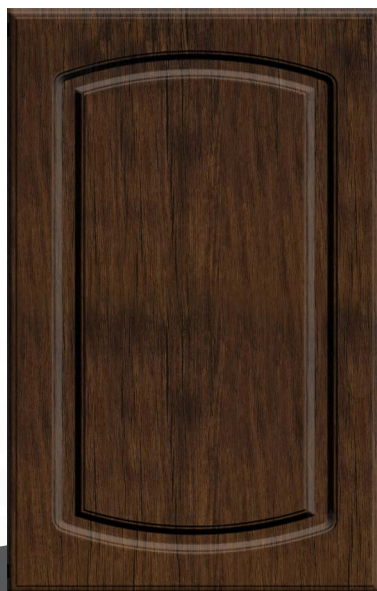

plné

výška od 220 mm

náhradní tvar **40** do šířky 114 mm,  
náhradní tvar **46M** od šířky 115  
mm do 213 mm, viz. internet

prosklené

výška od 253 mm



šířka od 220 mm

mříž

výška od 253 mm



šířka od 222 mm

do výšky 699 mm 4 okna  
od výšky 700 mm 6 oken



zásuvka

výška 110-219 mm

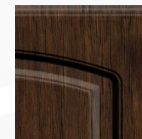

detail

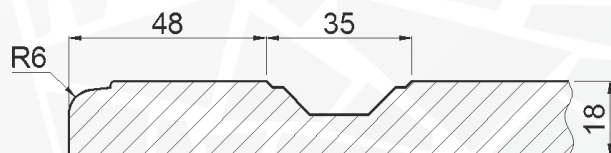

## TVAR 47 DUB FERRARA



plné

výška od 215 mm

náhradní tvar 40 do šířky 114 mm,  
náhradní tvar 47M od šířky 115  
mm do 213 mm, viz. internet

prosklené



výška od 253 mm

šířka od 220 mm



zásuvka  
výška 95-214 mm

mříž



výška od 265 mm

šířka od 220 mm

do výšky 699 mm 4 okna  
od výšky 700 mm 6 oken

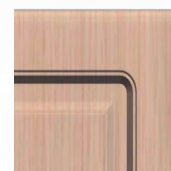

detail

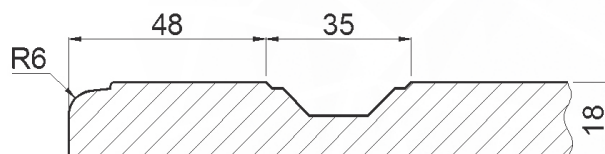

## TVAR 48 BANÁN



plné

výška od 253 mm

do šířky 139 mm pouze obvodové  
frézování, náhradní tvar 48A od šířky  
140 mm do 195 mm, náhradní tvar  
48B od šířky 196 mm do 251 mm,  
viz. internet

prosklené

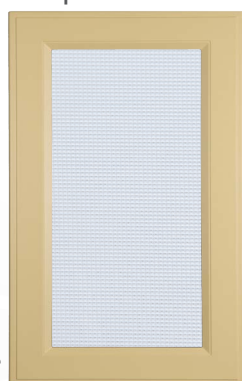

výška od 253 mm

šířka od 220 mm



zásuvka  
výška 106-252 mm

mříž



výška od 440 mm

od šířky 220 mm do 438 mm 4 okna  
od šířky 439 mm 6 oken



detail

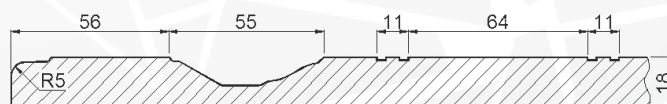

## TVAR 49

BÍLÁ PERLIČKA



plné

výška od 253 mm

do šířky 139 mm pouze obvodové frézování, náhradní tvar 48A od šířky 140 mm do 195 mm, náhradní tvar 48B od šířky 196 mm do 251 mm, viz. internet

prosklené

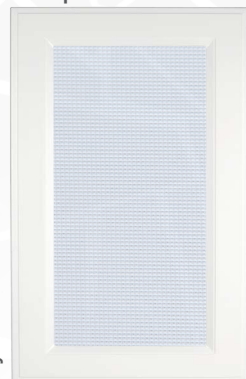

výška od 253 mm

šířka od 220 mm

mříž



výška od 253 mm

šířka od 220 mm

do výšky 699 mm 4 okna  
od výšky 700 mm 6 oken

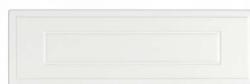

zásuvka

výška 106-252 mm



detail

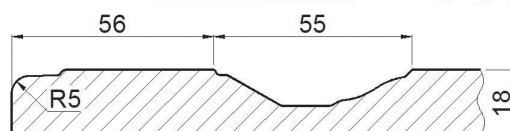

## TVAR C2

VANILKA



plné

výška od 286 mm

náhradní tvar bez vnitřního frézování do šířky 146 mm od šířky 147 mm, viz. internet

prosklené



výška od 253 mm

šířka od 220 mm

mříž



výška od 270 mm

šířka od 265 mm



zásuvka

výška 95-285 mm

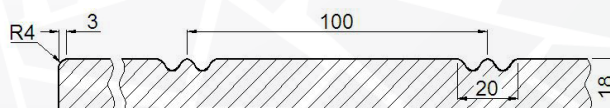

TVAR **K7**  
MODŘÍN ŠEDÝ



plné

výška od 221 mm

náhradní tvar **K0** do šířky 187 mm

prosklené



výška od 253 mm

šířka od 220 mm



zásuvka  
výška 95-220 mm

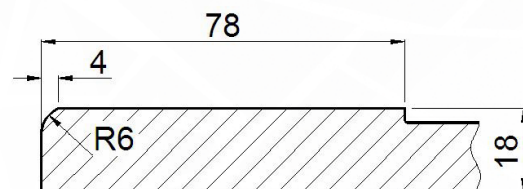

TVAR **CC**  
PERLEŤ BÍLÁ

Obvodové frézování ze 3 stran - TVAR C0



plné

výška od 106 mm

dvířko je osazeno madlem RAMARA  
tvar vyráběn v šířkách: 146 mm, 196 mm, 296 mm,  
346 mm, 396 mm, 446 mm, 496 mm, 596 mm,  
796mm, 896 mm, 996 mm, 1196 mm

prosklené

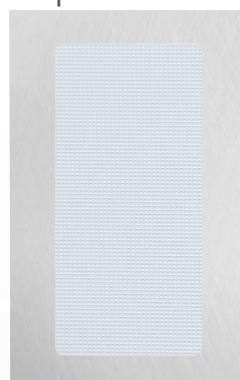

výška od 253 mm

šířka od 296 mm



PROVEDENÍ  
IMITACE NEREZ

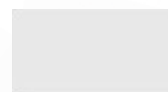

PROVEDENÍ  
HLINIK

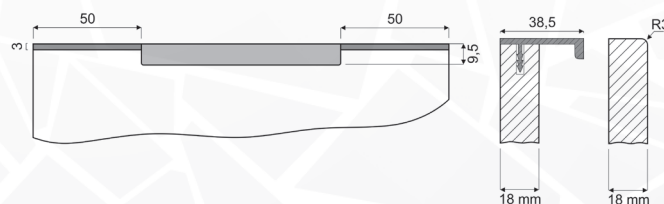

**DVÍŘKA**  
S LIŠTOVÝMI  
ÚCHYTKAMI

## TVAR U2V

WENGE



PROVEDENÍ  
IMITACE NEREZ

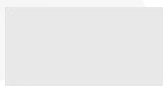

PROVEDENÍ  
HLINIK

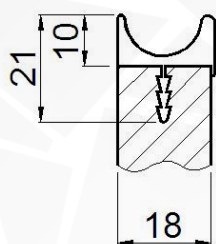

prosklené



Obvodové frézování - TVAR C0, radius 3mm

## TVAR U3V

WOODLINE TMAVÝ



Obvodové frézování - TVAR C0, radius 3mm

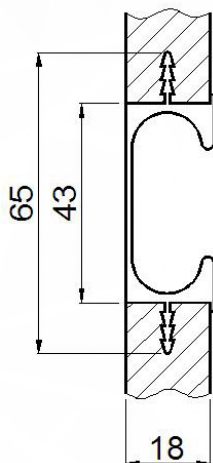

## TVAR U1V

KAPUCINO-VYSOKÝ LESK



prosklené

Obvodové frézování - TVAR C0, radius 3mm

## TVAR U4V

PERLET BÍLÁ

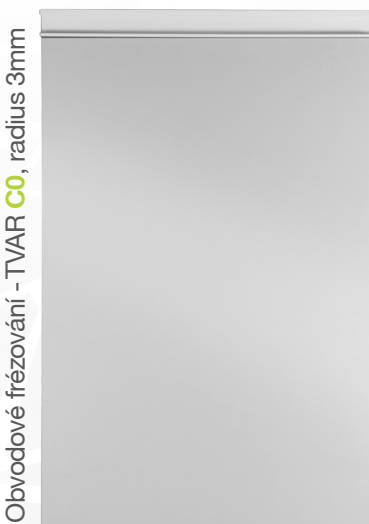

Obvodové frézování - TVAR C0, radius 3mm

prosklené

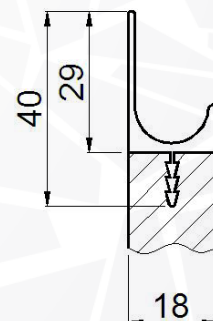
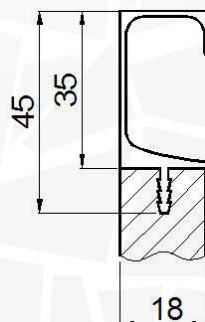

## TVAR U5

OCEÁN



plné

výška od 142 mm  
náhradní tvar C0 do šířky 200 mm

PŘESAH MADLA NAD DVÍŘKEM: 1 mm  
(přesah není započten do celkového rozměru dvířka)

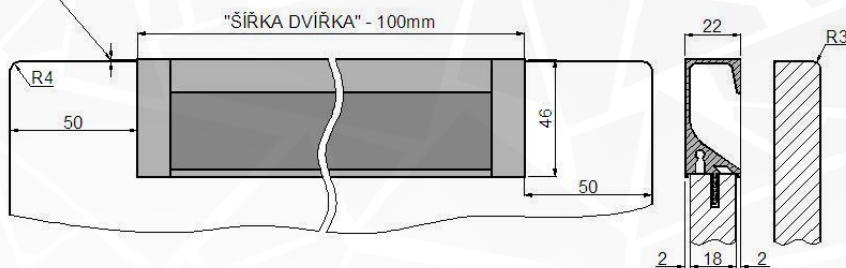

prosklené



výška od 286 mm

Obvodové frézování - TVAR C0, radius 3mm

Barva úchytky - HLINÍK

## TVAR CA

JASMÍN-VYSOKÝ LESK

Barva úchytky - NIKL MAT.

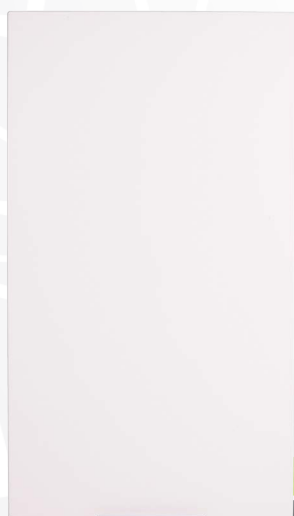

plné

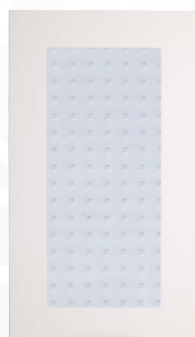

prosklené

Výška od 253 mm

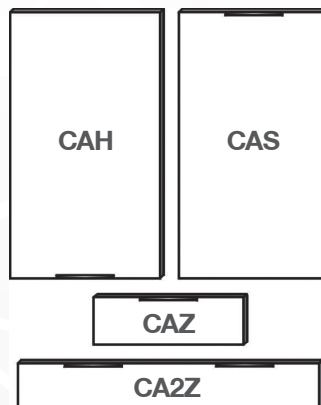
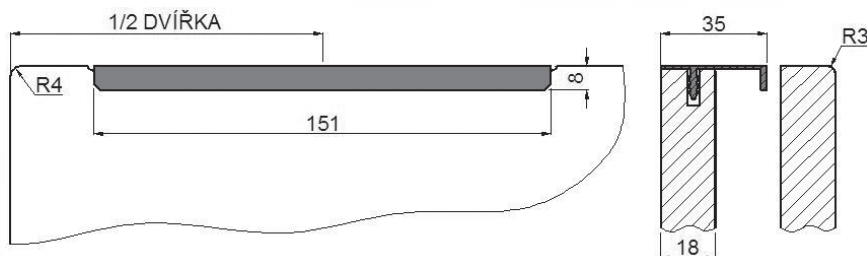

Obvodové frézování - TVAR C0, radius 3mm

## TVAR J KIWI VYSOKÝ LESK

Barva úchytky - HLINÍK

Obvodové frézování -  
TVAR C0, radius 3mm

PŘESAHA MADLA NAD DVÍŘKEM: 1 mm  
(přesah není započten do celkového rozměru dvířka)

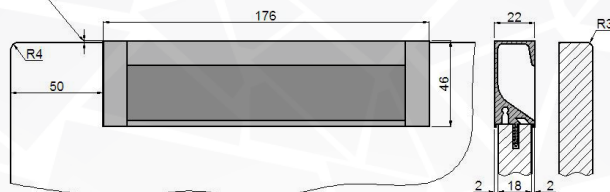

plné

výška od 286 mm

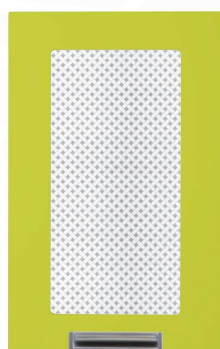

prosklené

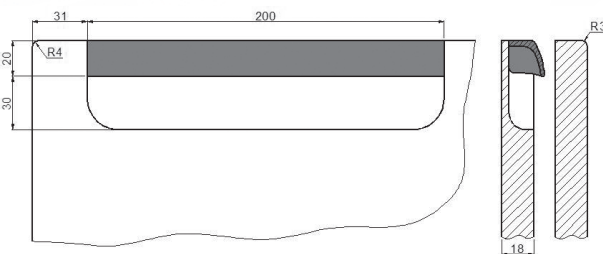
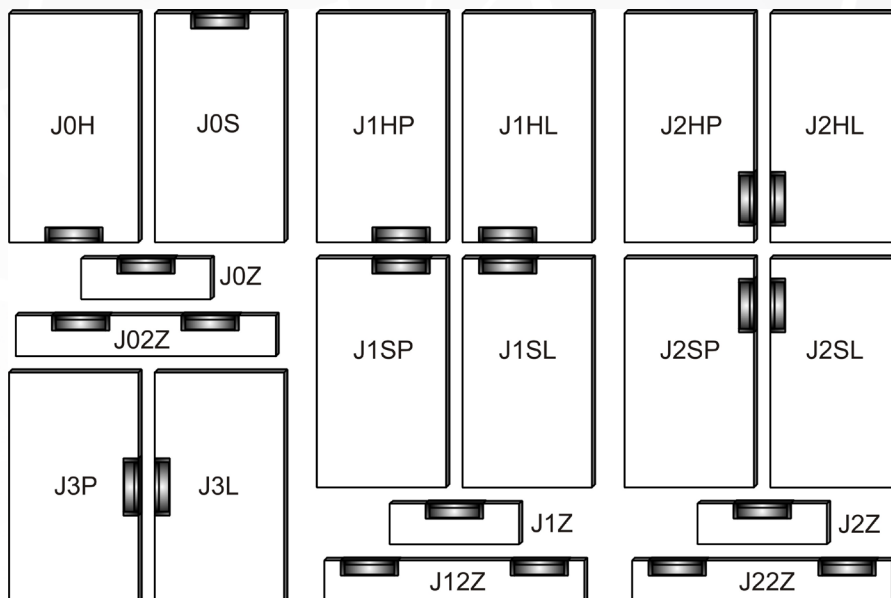

## TVAR Q KVĚT ČERNÝ 2 LESK

Barva úchytky - CHROM MAT.



plné

výška od 286 mm

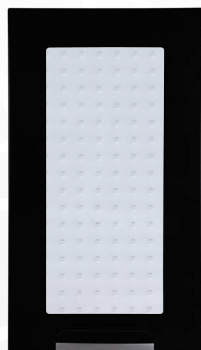

prosklené

Obvodové frézování - TVAR C0, radius 3mm

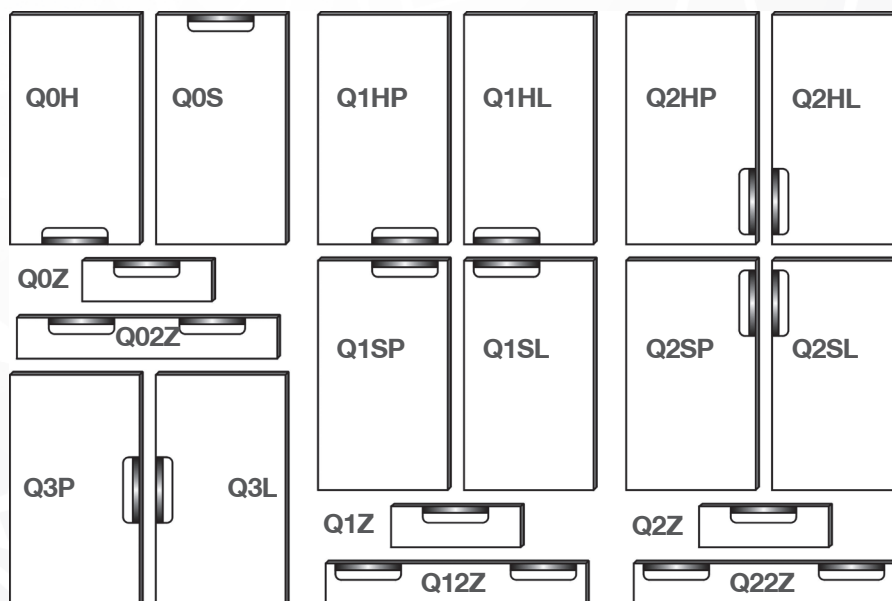



plné

Výška od 286 mm

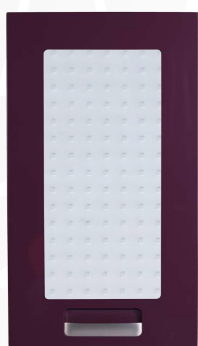

prosklené

Obvodové frézování - TVAR C0, radius 3mm

## TVAR S

PURPURA-VYSOKÝ LESK

Barva úchytky - CHROM MAT.

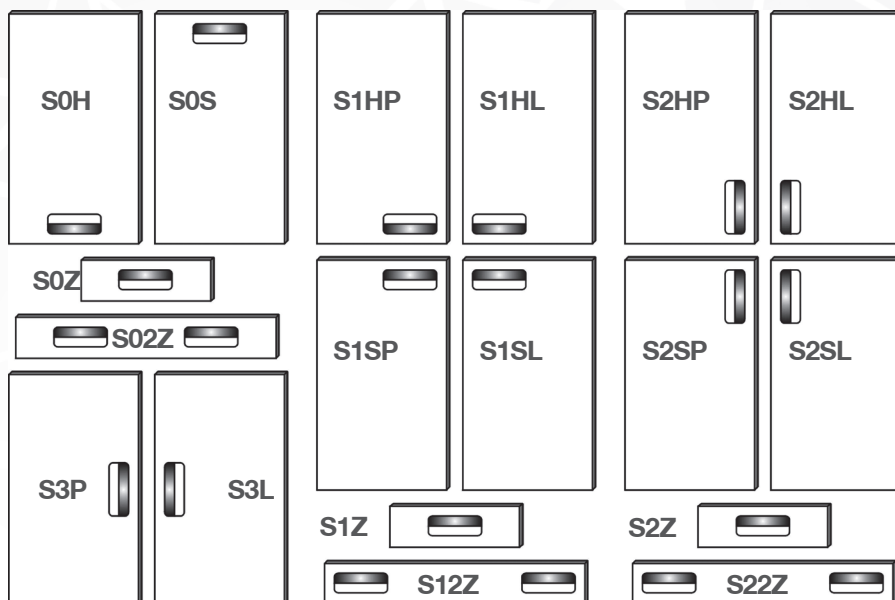
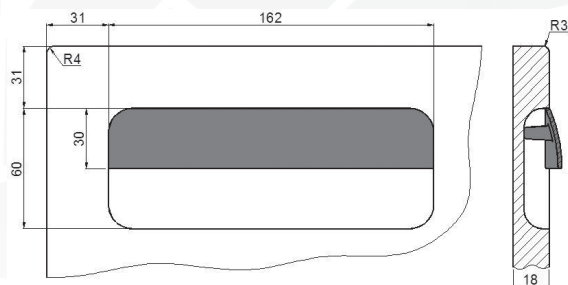

## TVAR W

GRAFIT-VYSOKÝ LESK

Barva úchytky - HLINÍK

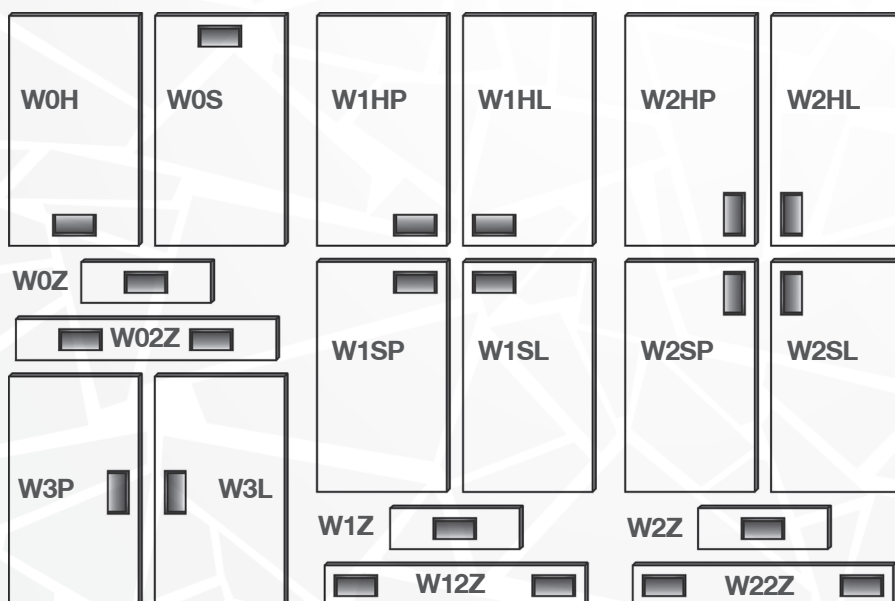
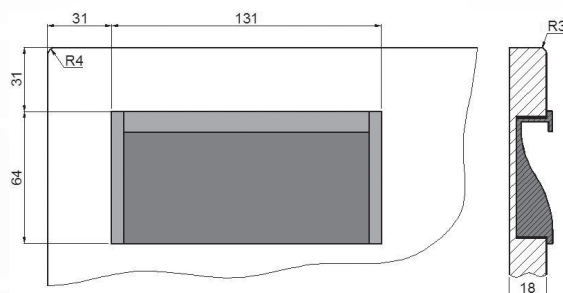

plné



Výška od 286 mm

prosklené

Obvodové frézování - TVAR C0, radius 3mm





plné



Výška od 286 mm

prosklené

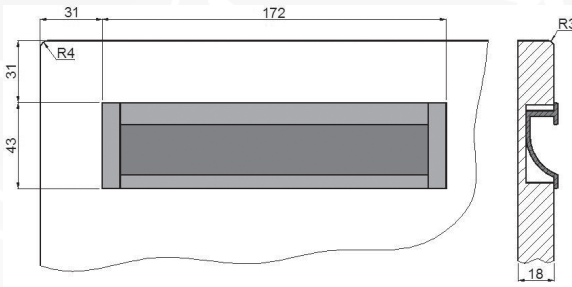

**TVAR X**  
AKACIE

Barva úchytky - CHROM MAT.  
- IMITACE NEREZ

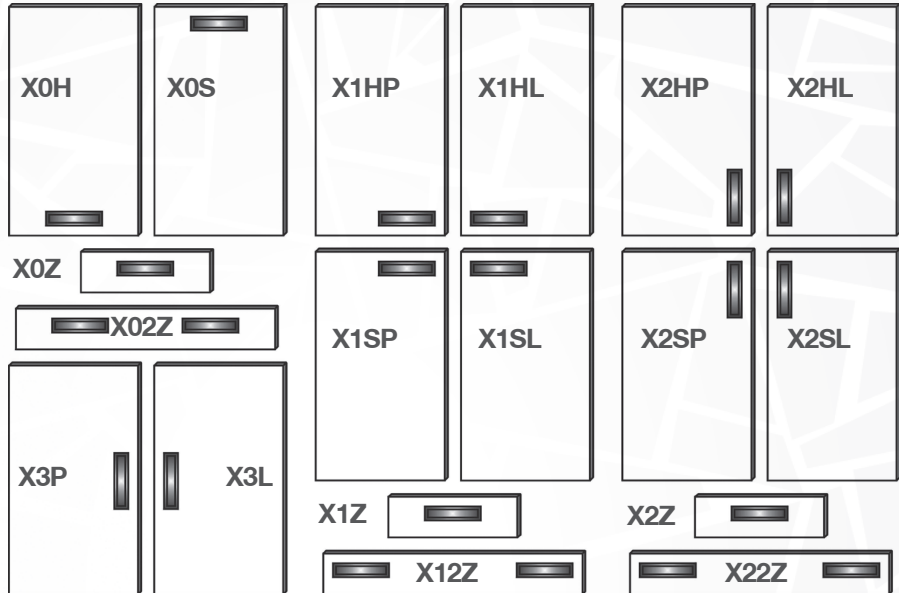

Obvodové frézování - TVAR C0, radius 3mm

**TVAR Z**  
ČERVENÁ-VYSOKÝ LESK

Barva úchytky - CHROM MAT.  
- CHROM

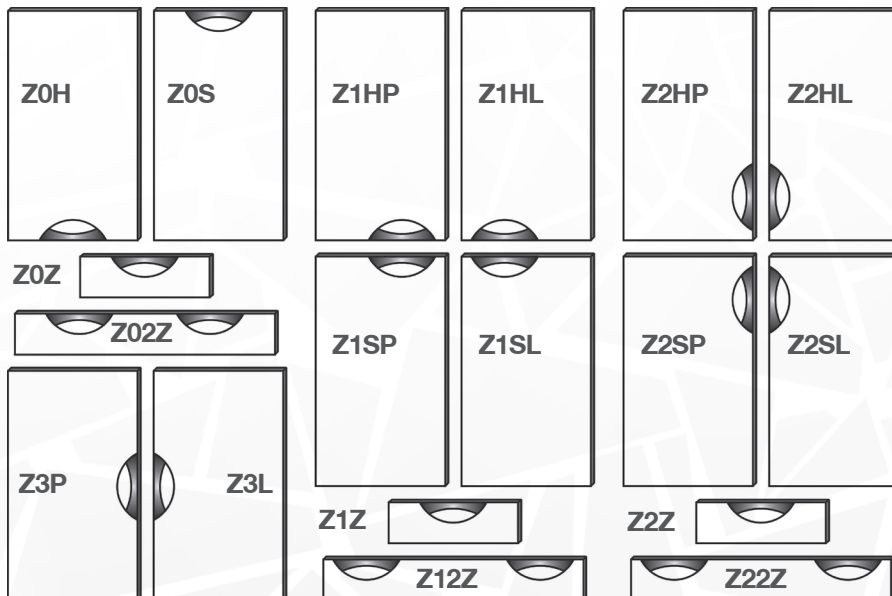
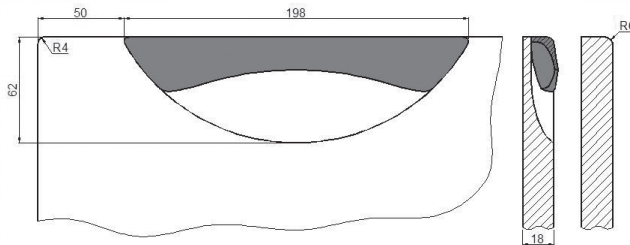

plné

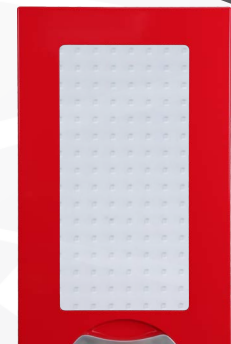

Výška od 286 mm

prosklené

Obvodové frézování - TVAR K0, radius 6mm

## DOPLŇKOVÁ DVIŘKA

RSB

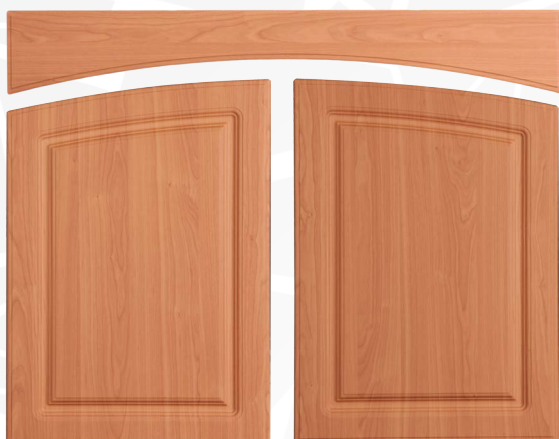

RSL

RSP

PROTVARY: R1, R2, R3, R4, R5

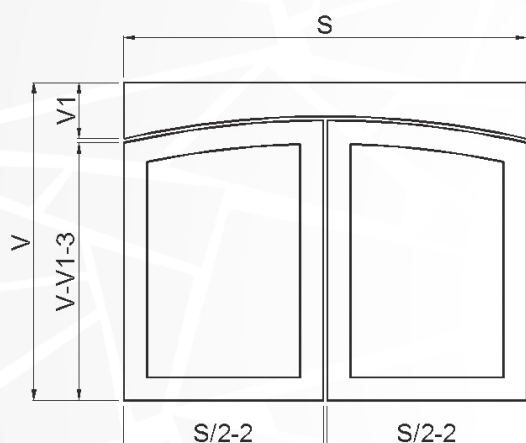
VZOREČKY VÝPOČTU ROZMĚRŮ  
KOMPONENTŮ SESTAV RS A 48

R1HL



R1HP



PROTVARY: R1, R2, R3, R4, R5

R1HL,R1HP

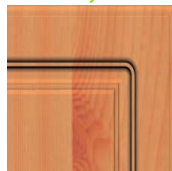

min. šířka 238 mm

R2HL,R2HP

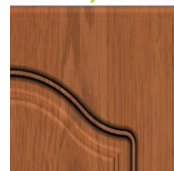

min. šířka 241 mm

R3HL,R3HP



min. šířka 238 mm

R4HL,R4HP

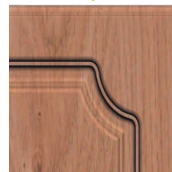

min. šířka 255 mm

R5HL,R5HP



min. šířka 396 mm

48SB



48

48SL

48SP



min. šířka 296 mm

48HL



48HP



Ize kombinovat i s tvarem 49

Upozornění: uvedená vyobrazení všech výrobků a povrchů jsou pouze ilustrativní, při objednávce vycházejte z aktuálního vzorníku materiálů.

Podrobnější technické údaje naleznete v Technickém listu na [www.hefas.cz](http://www.hefas.cz)

# OZDOBNÁ ČELA A LISTELY

**44B2**  
pro tvar M0, 44



**EB2**  
pro tvar E2



**4B2**  
pro tvar 41, 42, 43, 46, 47



**48B2**  
pro tvar 48



**RB2**  
pro tvar R0, R1, R2, R3, R4, R5, D1, D2, D3, D4



min. šířka 346 mm  
min. výška 125 mm

**44B1**  
pro tvar M0, 44



**EB1**  
pro tvar E2



**4B1**  
pro tvar 41, 42, 43, 46, 47



**48B1**  
pro tvar 48



**RB1**  
pro tvar R0, R1, R2, R3, R4, R5, D1, D2, D3, D4



min. šířka 346 mm  
min. výška 106 mm

**L2** **L1**



**L1**  
šíře 50 mm  
výška 300 - 2200 mm  
tloušťka 18 mm

**L2**  
šíře 50 mm  
výška 300 - 2200 mm  
tloušťka 18 (28) mm

**PV2** PODPĚRA NA LAHVE



**PV2**  
šíře 870 mm  
výška 200 mm  
tloušťka 18 mm

## STOLOVÉ DESKY

# STOLOVÉ DESKY

## 3D PROFIL

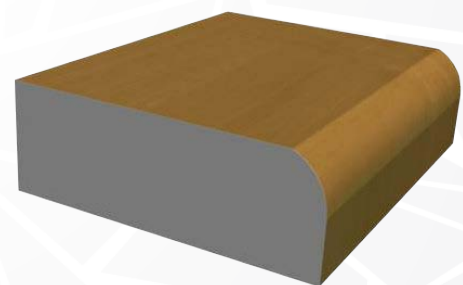
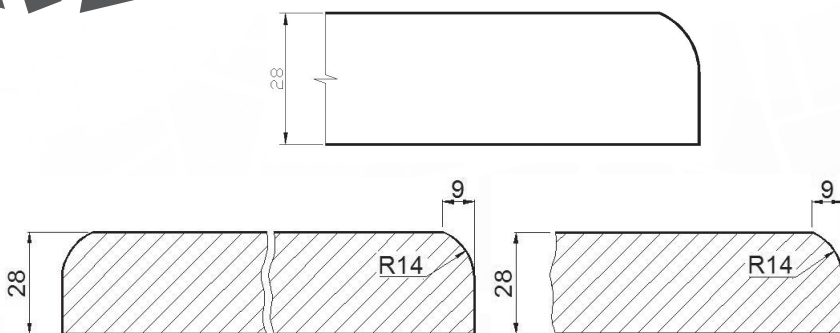

**TVAR SD1**  
elipsa

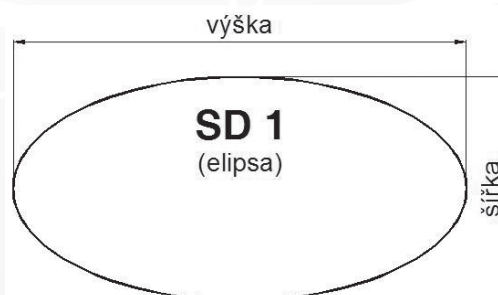

### UPOZORNĚNÍ:

POUŽITÝ MATERIÁL NENÍ ABSOLUTNĚ ODOLNÝ PROTI POŠKRÁBÁNÍ A OTĚRU

Upozornění: uvedená vyobrazení všech výrobků a povrchů jsou pouze ilustrativní, při objednávce vycházejte z aktuálního vzorníku materiálů.

Podrobnější technické údaje naleznete v Technickém listu na [www.hefas.cz](http://www.hefas.cz)



TVAR **SD2**  
vypouklý obdélník

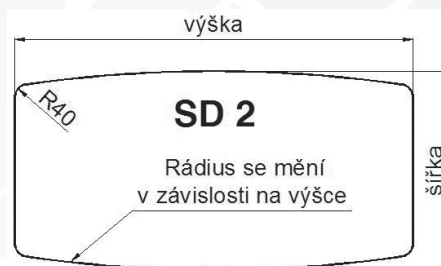

TVAR **SD3**  
kruh

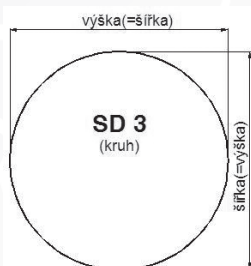

TVAR **SD4**  
obdélník



TVAR **SD5**



TVAR **SD6**

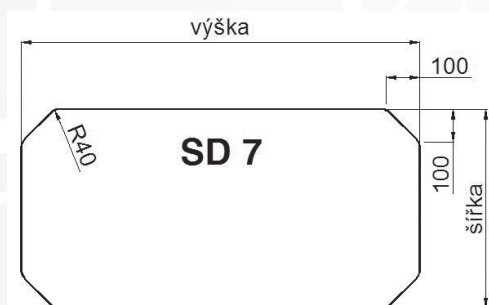
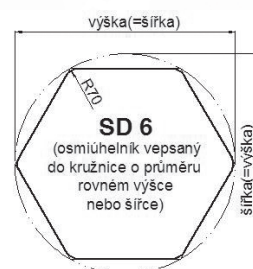

TVAR **SD7**



VÝROBA DALŠÍCH TVARŮ DLE TECHNICKÉ DOKUMENTACE ZÁKAZNÍKA

Upozornění: uvedená vyobrazení všech výrobků a povrchů jsou pouze ilustrativní, při objednávce vycházejte z aktuálního vzorníku materiálů.

Podrobnější technické údaje naleznete v Technickém listu na [www.hefas.cz](http://www.hefas.cz)

RAMPY  
FRÉZOVANÉ  
ze tří stran



TVAR **ROV1**  
oblouk



TVAR **ROV2**  
oblouk



TVAR **REV1**  
lomený oblouk



TVAR **REV2**  
lomený oblouk

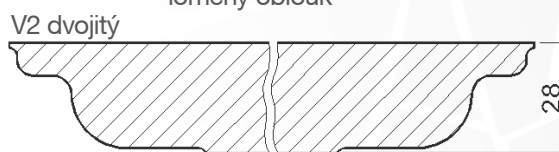
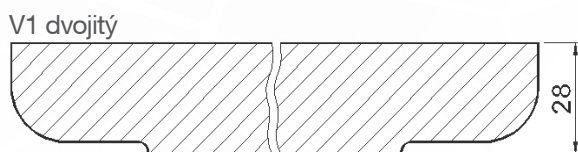

TVAR **RUV1**  
obdélník



TVAR **RUV2**  
obdélník



TVAR **RPV1**  
pokos



TVAR **RPV2**  
pokos

RAMPY  
FRÉZOVANÉ  
jednostranně

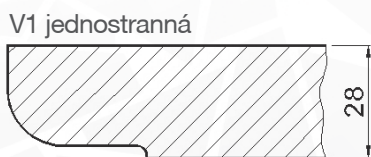

TVAR **RRV1**  
jednostranná



TVAR **RRV2**  
jednostranná



# VĚNCOVÉ LIŠTY

TVAR V1

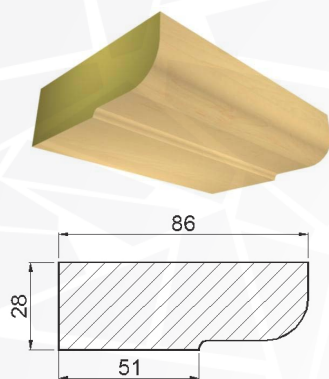

TVAR V2

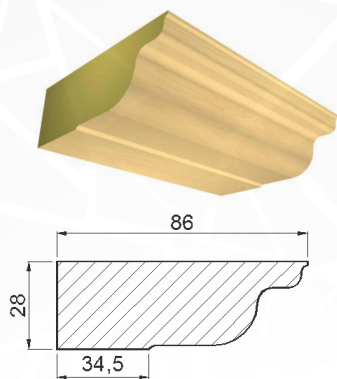

TVAR V3

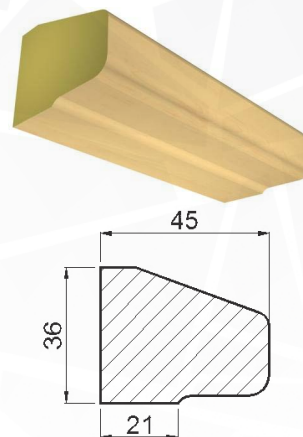

TVAR V4

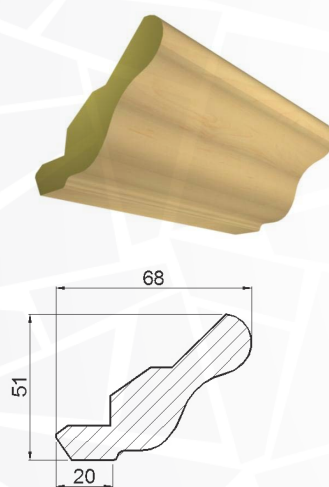

TVAR V5

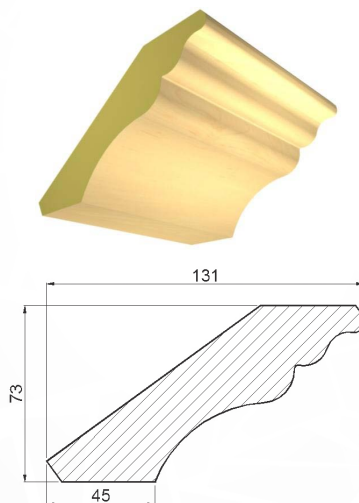

TVAR V6

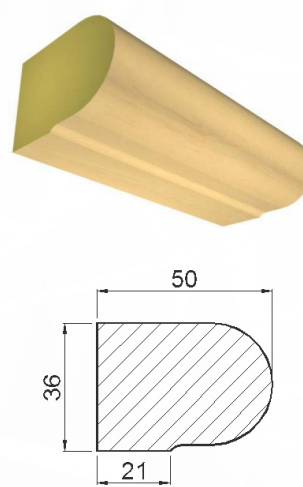

TVAR V7

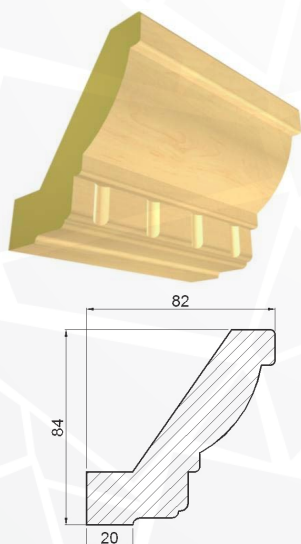

TVAR V8

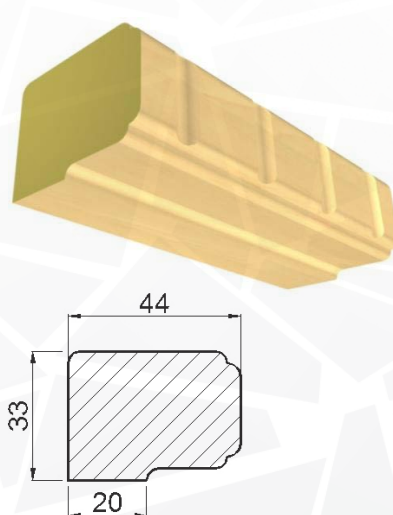

Upozornění: uvedená vyobrazení všech výrobků a povrchů jsou pouze ilustrativní, při objednávce vycházejte z aktuálního vzorníku materiálů.

Podrobnější technické údaje naleznete v Technickém listu na [www.hefas.cz](http://www.hefas.cz)

## VÝŠKY 720MM

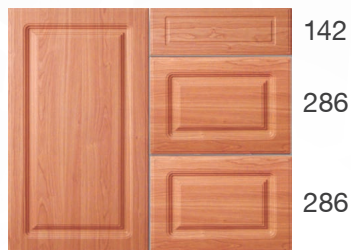
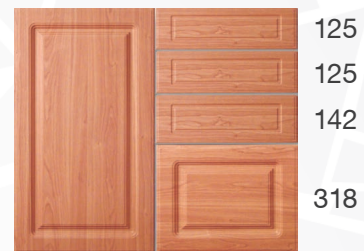

### SMĚR DEKORU FÓLIE

POKUD NEBUDE V OBJEDNÁVCE UVEDEN SMĚR DEKORU, PLATÍ NÁSLEDUJÍCÍ PRAVIDLO:

U DVÍŘEK DO VÝŠKY 318 MM BUDE SMĚR DEKORU UMÍSTĚN VODOROVNĚ, OD VÝŠKY 319 MM BUDE SMĚR DEKORU UMÍSTĚN SVISLE.

## VÝŠKY 702MM

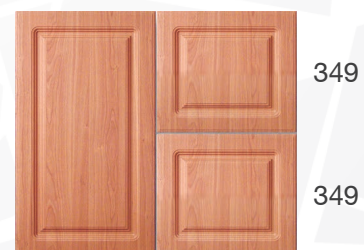

Skládaná dvířka jsou vyráběna z LTD se zvýrazněnou strukturou věrně imitující dřevo.

AKÁCIE LAKELAND TVAR **LS1**

plné



výška od 181 mm

šířka od 181 mm

prosklené



výška od 181 mm

šířka od 181 mm

SKLÁDANÝ Z PĚTI DÍLŮ

rám - LTD tl. 18 mm  
výplň - LTD tl. 8 mm  
hrana - identická s materiálem rámu

zásuvka

výška do 180 mm



min. šířka 70 mm

AKÁCIE LAKELAND TVAR **LS2**

plné



výška od 700 mm

šířka od 246 mm

prosklené



šířka od 246 mm

šířka od 180 mm

SKLÁDANÝ ZE SEDMI DÍLŮ

rám - LTD tl. 18 mm  
výplň - LTD tl. 8 mm  
hrana - identická s materiálem rámu

výška od 181 mm do 699 mm



šířka od 180 mm

zásuvka



min. šířka 70 mm



## TVAR LS3 GREY GLADSTONE



šířka od 181 mm



šířka od 181 mm

### SKLÁDANÝ ZETŘÍ DÍLŮ

rám - LTD tl. 18 mm  
výplň - LTD tl. 18 mm  
hrana - dle vzorníku

### zásuvka

výška do 126 mm



min. šířka 70 mm

## DEKORY MATERIÁLŮ PRO SKLÁDANÁ DVÍŘKA



**Grey Gladstone**  
H 3326/ST 28



**Tabák Gladstone**  
H 3325/ST 28



**Dub Bardolino  
přírodní**  
H 1145/ST 10



**Akácie Lakeland  
světlá**  
H 1227/ST 9



**Pinie Cascina**  
H 1401/ST 22



**Bílá prémium**  
W 100/ST 38

- nabízíme 18 designových motivů pro použití do nábytku, vestavných skříní, interiérových dveří či samostatně
- tloušťka skla 4 mm
- rozměry dle přání zákazníka (maximálně 1200 mm x 2500 mm)
- bezproblémová údržba, stálost, odolnost

## NABÍZENÉ TYPY SKEL:

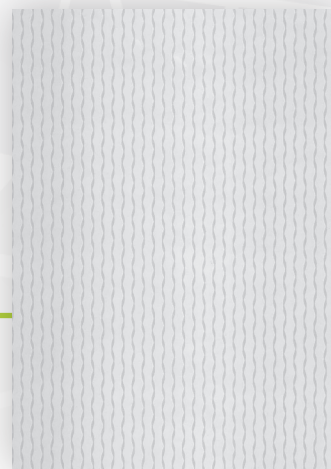

Wave

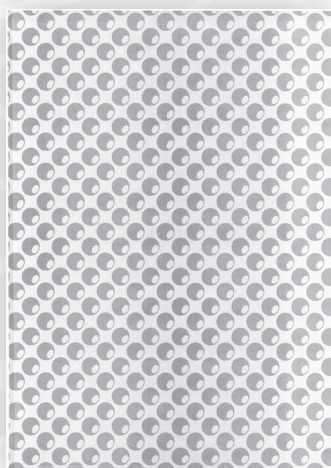

Bubbles



Cannabis



Cucinamania



Circles



Cross



Feather

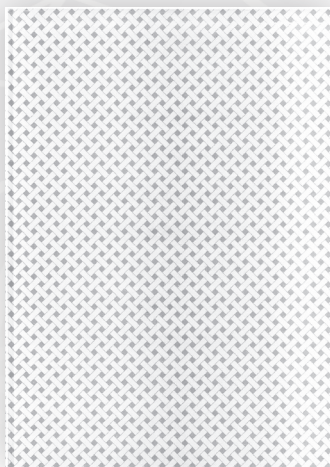

Grate



China



Palm leaf

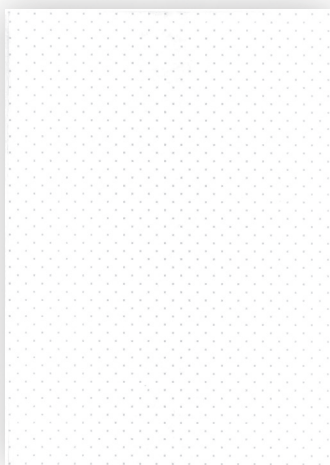

Quadratic



Ribbon

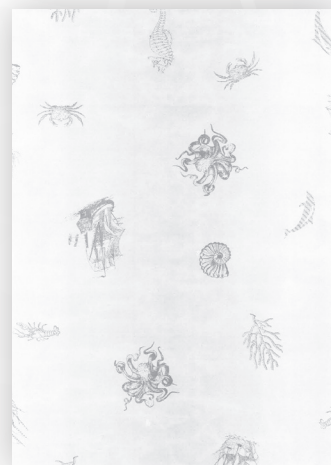

Sea world

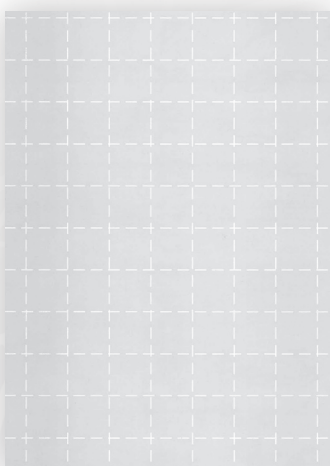

Squares



Time



Trilobite

# HLINÍKOVÁ DVÍŘKA

A3

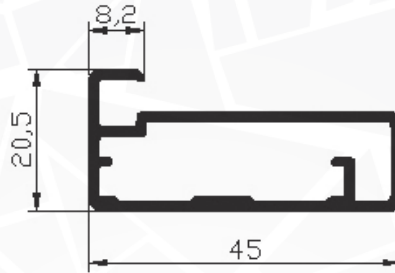
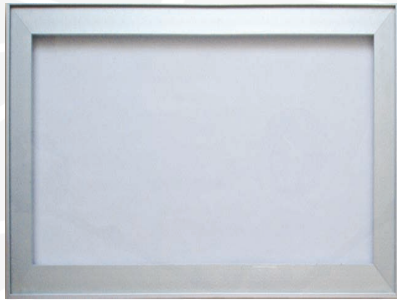

A4

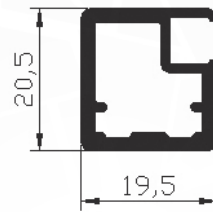

A5

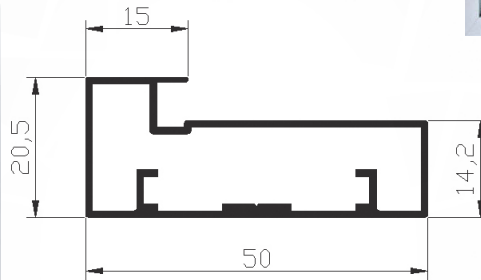

A6

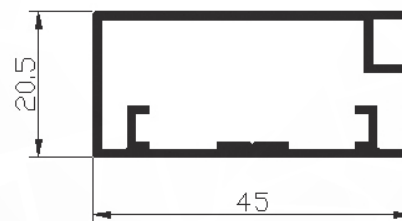

A7

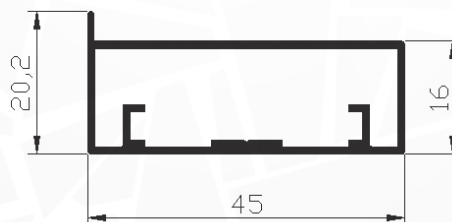

PROVEDENÍ  
IMITACE NEREZ



PROVEDENÍ  
HLINÍK

Vytvořte si unikátní interiér s využitím námi digitálně potištěných materiálů. Odolný digitální UV tisk je vhodný pro plošné materiály **do tl. 50 mm** a max. rozměrů **1300 mm x 2495 mm**.

### Možnosti využití tisku:

- na fóliovaných, akrylátových a LTD dvířkách
- na obkladových panelech za kuchyňské linky
- na skla a nábytkové plochy
- na skleněné zástěny, interiérové dveře, vestavěné skříně
- fotoobrazy

Příklady realizací  
interiérů s využitím  
našich výrobků

Nabízíme přes 1000  
UNI barev pro sklo  
a LTD.



Široký výběr grafických  
motivů z naší nabídky.

Nabízíme také možnost potisku vlastním  
motivem v odpovídající kvalitě.

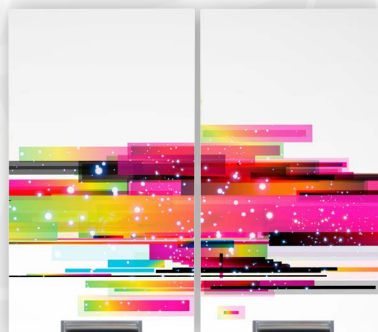
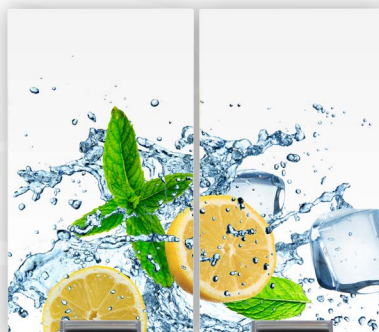

## Akrylátová a extra matná dvířka

- akrylátová i extra matná dvířka jsou ohraněna nejmodernější bezspárovou technologií
- vysokolesklý povrch akrylátových dvířek je stupněm lesku plně srovnatelný s lakovanými dvířky nejvyšší kvality včetně hran
- povrch extra matných dvířek je ze speciálního laminátu Duropal HPL XTreme se zvýšenou odolností proti poškrábání, znečištění potem, otisky prstů, krémy a dalšími látkami
- dodáváme dle vámi požadovaných rozměrů včetně ohranění bez příplatku za atypický rozměr
- nabízíme široký výběr hran: identické unifarvy, akrylátové hrany 2v1

### NABÍZENÉ AKRYLÁTOVÉ DEKORY:

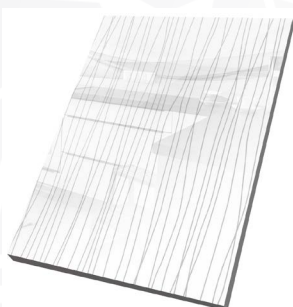

**Akryl bílá nit**  
zadní strana: bílá



**Akryl černá nit**  
zadní strana: černá



**Akryl bílý SCR**  
zadní strana: bílá



**Akryl vanilka SCR**  
zadní strana: vanilka



**Akryl rubín**  
zadní strana: akryl rubín

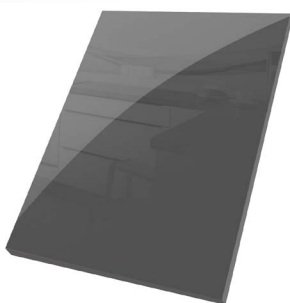

**Akryl antracit**  
zadní strana: akryl antracit



**Akryl černý**  
zadní strana: akryl černý



**Akryl kapučíno SCR**  
zadní strana: kapučíno SCR

### DUROPAL HPL XTREME



**Magnolie mat XM**  
zadní strana magnolie



**Bílá mat XM**  
zadní strana bílá



**Černá mat XM**  
zadní strana černá

## Akrylátové hrany 2v1 (tl. 1,3 mm):

Imitují skleněný povrch na hraně výrobku



ukázka ohranění



Nabízená provedení:



Bílá + hliník **LA10**



Vanilka + hliník **LA11**



Rubín + hliník **LA12**



Černá + hliník **LA13**



Bílá + bílá mat. **LA14**



Černá + černá mat. **LA15**

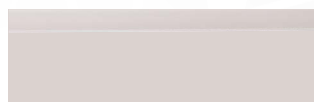

Vanilka + vanilka mat **LA14**



Antracit + hliník **LA17**

## Laserové hrany - unibarvy

Nabízí dokonalý spoj pro celistvý vzhled jako u lakovaných dřevěk

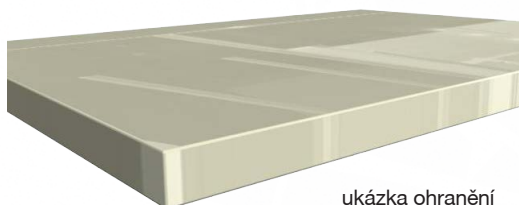

ukázka ohranění

Nabízená provedení:



laser-uni-bílá  
**LA 00** TL. 1,3 mm



laser-uni-vanilka  
**LA01** TL. 1,3 mm



laser-uni-rubín  
**LA 02** TL. 1,3 mm



laser-uni-kapučínó  
**LA 08** TL. 1,3 mm



laser-uni-antracit  
**LA 04** TL. 1,3 mm



laser-uni-černá  
**LA 03** TL. 1,3 mm

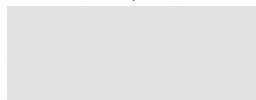

laser-uni-bílá mat  
**LA 05** TL. 1 mm



laser-uni-černá mat  
**LA 06** TL. 1 mm



laser-uni-magnolie mat  
**LA 07** TL. 1 mm

## Laserové hrany - fazeta 45° (tl. 2mm)

Nabízí dokonalý spoj ve fazetovém provedení



ukázka ohranění

Nabízená provedení:



laser-uni-bílá 45°  
**TVAR LA35**



laser-uni-černá 45°  
**TVAR LA36**

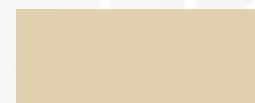

laser-uni-magnolie 45°  
**TVAR LA37**

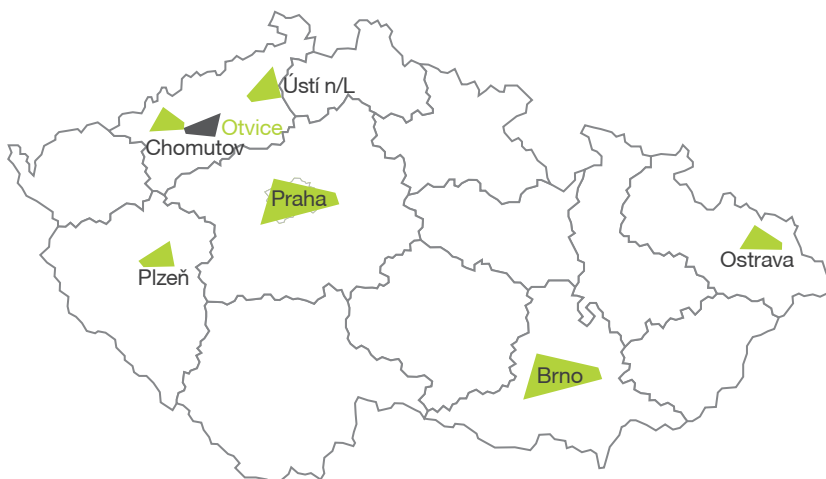

**HEFAS S.R.O.**  
Stará 1, 431 11 Otvice  
tel.: 474 684 616  
mob.: 777 684 616  
fax: 474 684 058  
obchod@hefas.cz  
[www.hefas.cz](http://www.hefas.cz)

VÁŠ DODAVATEL: